

# LOT ELECTRICITE

\*\*

--

## TABLEAU DIVISIONNAIRE SALLE DE SPORT

## SCHEMA ELECTRIQUE

Logo et adresse Entreprise

**BARROS ELECTRICITE**

14, Rue Duplex  
78500 - SARTROUVILLE

Logo et Adresse de l'Emetteur du document



20B, Rue Voltaire Pin  
27120 - AIGLEVILLE  
Tél: 06.10.62.05.24  
societtd2i@gmail.com

### PAGE DE GARDE

DATE: 31/03/2023 FOLIO N° 01/13 A

AFFAIRE N°: \_\_\_\_\_ PLAN N°: **23-049-001**

Ind.	Etabli par:	Vérifier par:	Date	Objet de la révision
A	EVD	S. RICARD	31/03/2023	Création document
.	.	.	.	.
.	.	.	.	.
.	.	.	.	.
-	--	--	--	-
-	--	--	--	-
-	--	--	--	-
-	--	--	--	-
-	--	--	--	-
-	--	--	--	-
-	--	--	--	-
-	--	--	--	-

CE DOCUMENT EST NOTRE PROPRIETE, IL NE PEUT PAS ETRE UTILISE SANS NOTRE AUTORISATION

FOLIO	DESCRIPTION	DATE
01/13 A	PAGE DE GARDE	31/03/2023
02/13 A	LISTE DES FOLIOS 1	31/03/2023
03/13 A	GENERAL FORCE	31/03/2023
04/13 A	CIRCUIT FORCE 1 - PC SERVICE	31/03/2023
05/13 A	CIRCUIT FORCE 2 - PC SERVICE	31/03/2023
06/13 A	CIRCUIT ECLAIRAGE 1	31/03/2023
07/13 A	CIRCUIT ECLAIRAGE 2 + ECL.EXTERIEUR	31/03/2023
08/13 A	CIRCUIT DEPART DIRECT + FORCE CASSETTE	31/03/2023
09/13 A	CIRCUIT FORCE CLIM (Suite) ET DIVERS	31/03/2023
10/13 A	CIRCUIT FORCE CARDIO 1/2 ET 3/4	31/03/2023
11/13 A	CIRCUIT FORCE CARDIO 5/6	31/03/2023
12/13A	CIRCUIT FORCE SECHE MAINS - SECHE SERVIETTE	31/03/2023
13/13 A	CIRCUIT FORCE CTA - ASCENSEUR	31/03/2023

CE DOCUMENT EST NOTRE PROPRIETE, IL NE PEUT PAS ETRE UTILISE SANS NOTRE AUTORISATION

TD SPORT	
U	230/400V
SLT	TNS
IK3 max:	15.169 kA
IK2 max:	13.137 kA
IK1 max:	10.682 kA
IK1 min:	7.655 kA
IK2 min:	9.903 kA
If:	.
Du:	0.32%

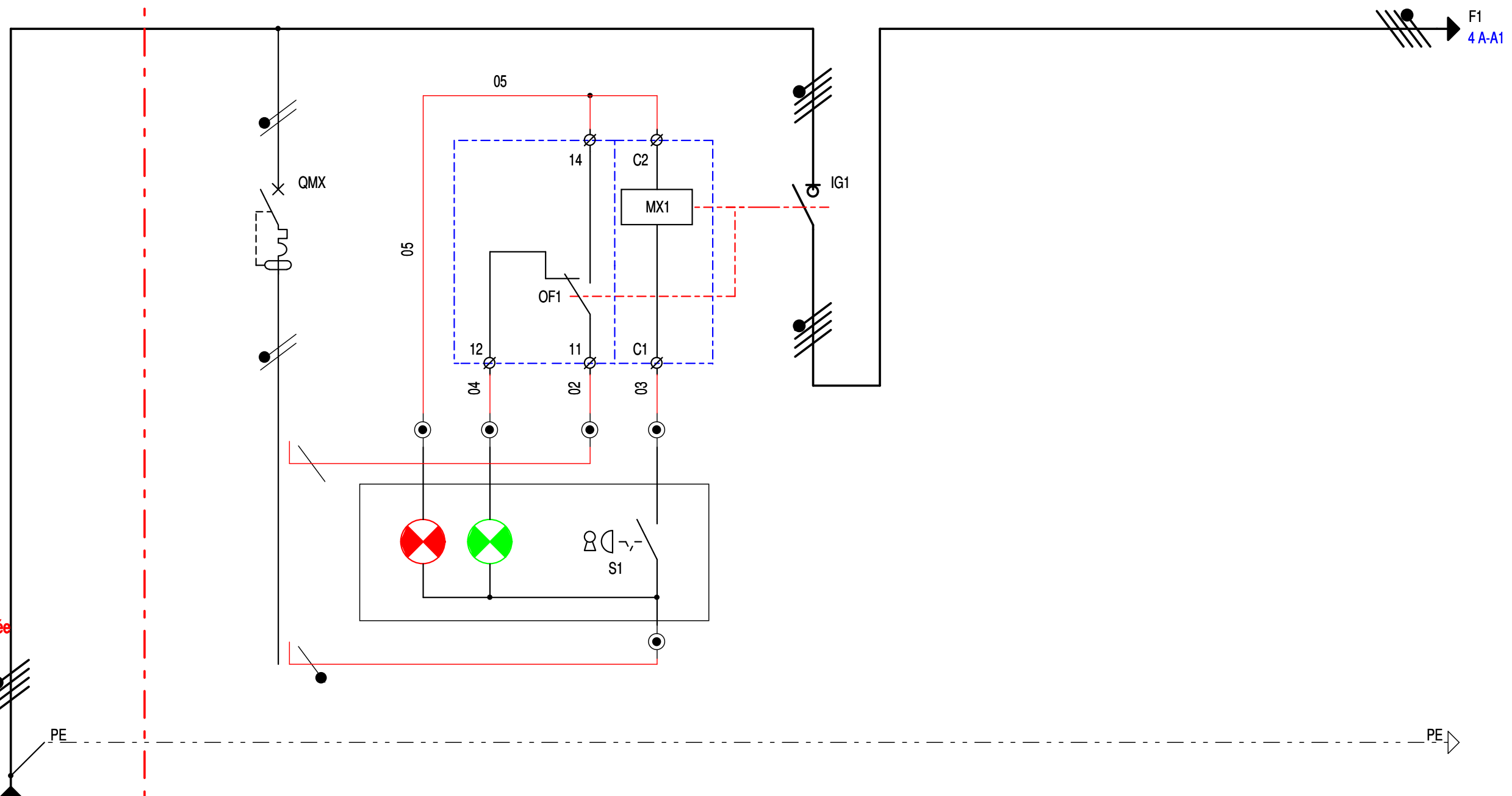

**Pour la réalisation du coffret**  
**Nous avons pris en compte :**

- La liste des différents départs
- Une alimentation à puissance surveillée
- De 15ml de câble 5G50 Cu
- D'une protection au niveau du TGBT d'un NG125N 4P125A-C (Non fourni)

CIRCUIT	REPERE		VENANT DU TGBT (Projet)		PROTECTION BOBINE DE DECLENCHEMENT		COUPURE GENERALE		
	DESIGNATION	lb							
	Puissance	lb	-	-	-	-	-	-	-
	Répartition	Cos-Phi	-	-	-	-	-	-	-
K Ut	DU Totale	-	-	-	-	-	-	-	
PROTECTION	TYPE		NG125N - C		iC60N - C		NG125NA		
	CAL.(A)	DECLENCH.	125	4P4D	10	2P2D	125	4P	
	Ir.Th.(A)	Img (A)	125	1250	10	100	-	-	
	PROTECTION CI (mA)		Prot.base		300mA/AC		Prot.base		
LIAISON	NATURE		U1000 R2V						
	LONGUEUR (m)	AME	15	CU	-	-	-	-	
	SECTION		5G50		-	-	-	-	
	NEUTRE	SEPRE	-	-	-	-	-	-	
	PE OU PEN	-	-	-	-	-	-		

DESSINE PAR: EVD  
 DATE: 31/03/2023

AFFAIRE: SALLE DE SPORT



20B Rue Voltaire Pin  
 27120 - AIGLEVILLE  
 Tel : 06.10.62.05.24

DESIGNATION DU FOLIO:  
 TABLEAU DIVISIONNAIRE SPORT  
 GENERAL FORCE

FOLIO:  
 03/13 A

CE DOCUMENT EST NOTRE PROPRIETE, IL NE PEUT PAS ETRE UTILISE SANS NOTRE AUTORISATION

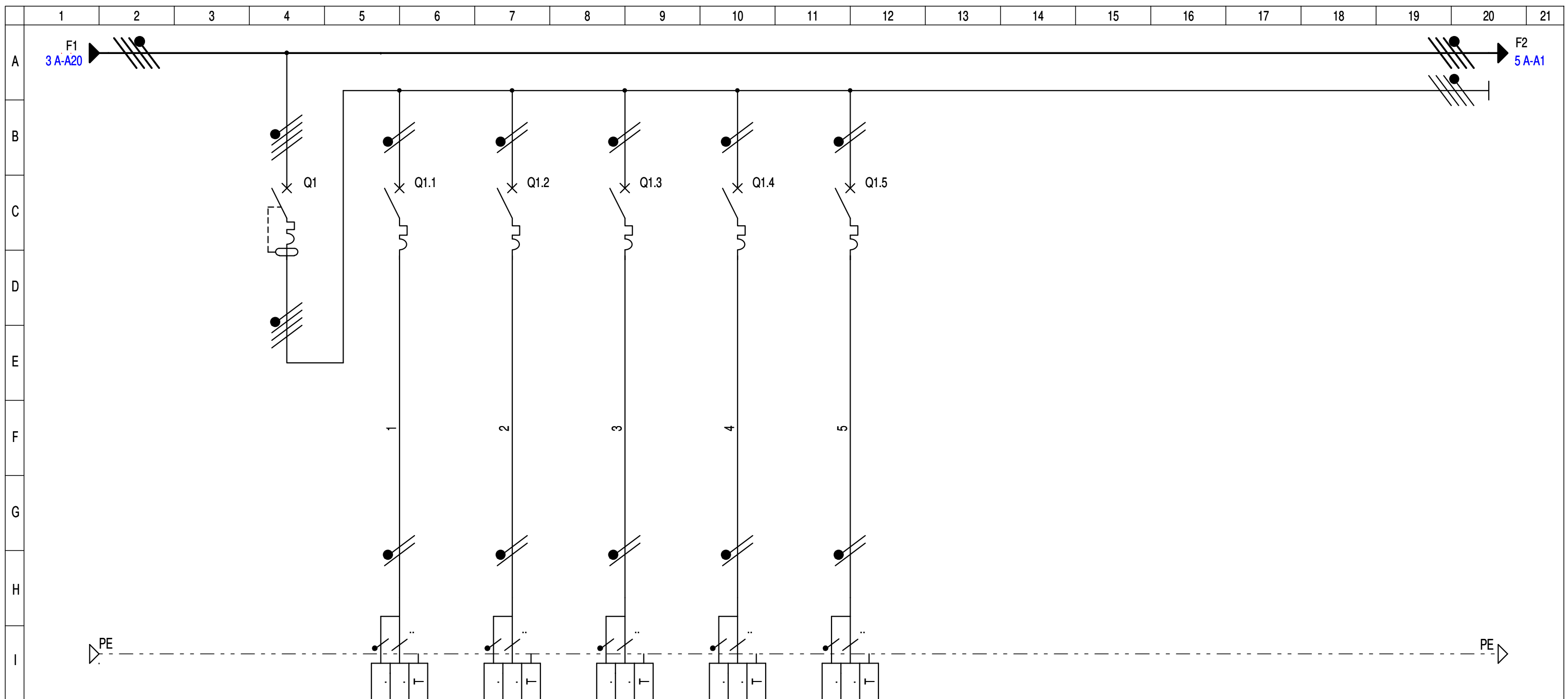

CIRCUIT	REPERE		GENERAL 1 PC SERVICE		PC1.1 PRISE DE COURANT SERVICE 1		PC1.2 PRISE DE COURANT SERVICE 2		PC1.3 PRISE DE COURANT SERVICE 3		PC1.4 PRISE DE COURANT SERVICE 4		PC1.5 PRISE DE COURANT SERVICE 5							
	Puissance	lb	-	-	-	-	-	-	-	-	-	-	-	-	-	-	-	-	-	-
	Répartition	Cos-Phi	-	-	-	-	-	-	-	-	-	-	-	-	-	-	-	-	-	-
	K Ut	DU Totale	-	-	-	-	-	-	-	-	-	-	-	-	-	-	-	-	-	-
PROTECTION	TYPE		iDT40N - C		iDT40T -C		iDT40T -C		iDT40T -C		iDT40T -C		iDT40T -C							
	CAL.(A)	DECLENCH.	40	3P+N	16	1P+N	16	1P+N	16	1P+N	16	1P+N	16	1P+N	-	-	-	-	-	-
	Ir.Th.(A)	Img (A)	40	400	16	160	16	160	16	160	16	160	16	160	-	-	-	-	-	-
	PROTECTION CI (mA)		30mA/AC		Prot.base		Prot.base		Prot.base		Prot.base		Prot.base							
LIAISON	NATURE																			
	LONGUEUR (m)	AME	-	-	-	-	-	-	-	-	-	-	-	-	-	-	-	-	-	-
	SECTION																			
	NEUTRE	SEPRE	-	-	-	-	-	-	-	-	-	-	-	-	-	-	-	-	-	-
	PE OU PEN		-	-	-	-	-	-	-	-	-	-	-	-	-	-	-	-	-	-

DESSINE PAR: EVD  
DATE: 31/03/2023

AFFAIRE: SALLE DE SPORT



20B Rue Voltaire Pin  
27120 - AIGLEVILLE  
Tel : 06.10.62.05.24

DESIGNATION DU FOLIO:  
TABLEAU DIVISIONNAIRE SPORT  
CIRCUIT FORCE 1 - PC SERVICE

FOLIO:  
04/13 A

CE DOCUMENT EST NOTRE PROPRIETE, IL NE PEUT PAS ETRE UTILISE SANS NOTRE AUTORISATION

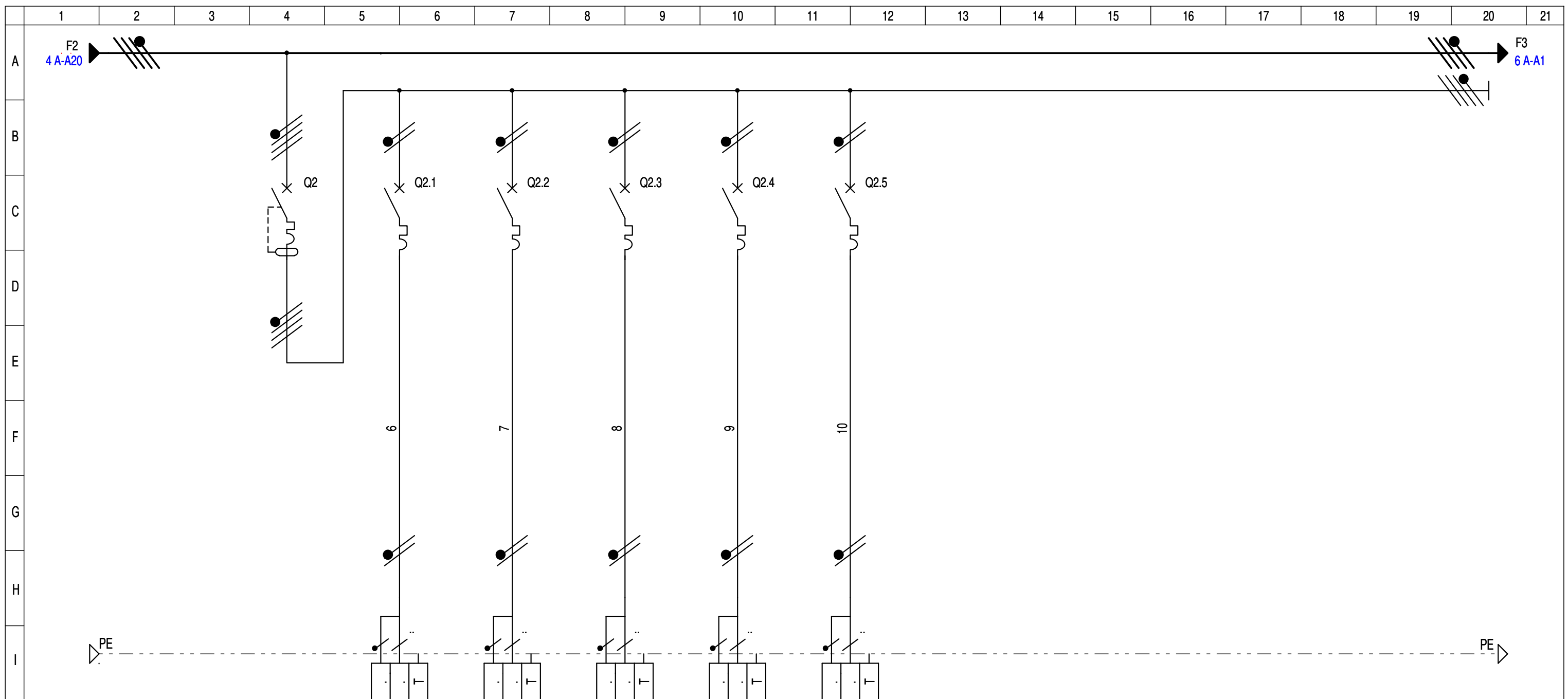

CIRCUIT	REPERE		GENERAL 2 PC SERVICE		PC2.1 PRISE DE COURANT SERVICE 6		PC2.2 PRISE DE COURANT SERVICE 7		PC2.3 PRISE DE COURANT SERVICE 8		PC2.4 PRISE DE COURANT SERVICE 9		PC2.5 PRISE DE COURANT SERVICE 10							
	Puissance	lb	-	-	-	-	-	-	-	-	-	-	-	-	-	-	-	-	-	-
	Répartition	Cos-Phi	-	-	-	-	-	-	-	-	-	-	-	-	-	-	-	-	-	-
	K Ut	DU Totale	-	-	-	-	-	-	-	-	-	-	-	-	-	-	-	-	-	-
PROTECTION	TYPE		iDT40N - C		iDT40T - C		iDT40T - C		iDT40T - C		iDT40T - C		iDT40T - C							
	CAL.(A)	DECLENCH.	32	3P+N	16	1P+N	16	1P+N	16	1P+N	16	1P+N	16	1P+N	-	-	-	-	-	-
	Ir.Th.(A)	lmg (A)	32	320	16	160	16	160	16	160	16	160	16	160	-	-	-	-	-	-
	PROTECTION CI (mA)		30mA/AC		Prot.base		Prot.base		Prot.base		Prot.base		Prot.base							
LIAISON	NATURE																			
	LONGUEUR (m)	AME	-	-	-	-	-	-	-	-	-	-	-	-	-	-	-	-	-	-
	SECTION																			
	NEUTRE	SEPRE	-	-	-	-	-	-	-	-	-	-	-	-	-	-	-	-	-	-
	PE OU PEN		-	-	-	-	-	-	-	-	-	-	-	-	-	-	-	-	-	-

DESSINE PAR: EVD  
DATE: 31/03/2023

AFFAIRE: SALLE DE SPORT



20B Rue Voltaire Pin  
27120 - AIGLEVILLE  
Tel : 06.10.62.05.24

DESIGNATION DU FOLIO:  
TABLEAU DIVISIONNAIRE SPORT  
CIRCUIT FORCE 2 - PC SERVICE

FOLIO:  
05/13 A

CE DOCUMENT EST NOTRE PROPRIETE, IL NE PEUT PAS ETRE UTILISE SANS NOTRE AUTORISATION

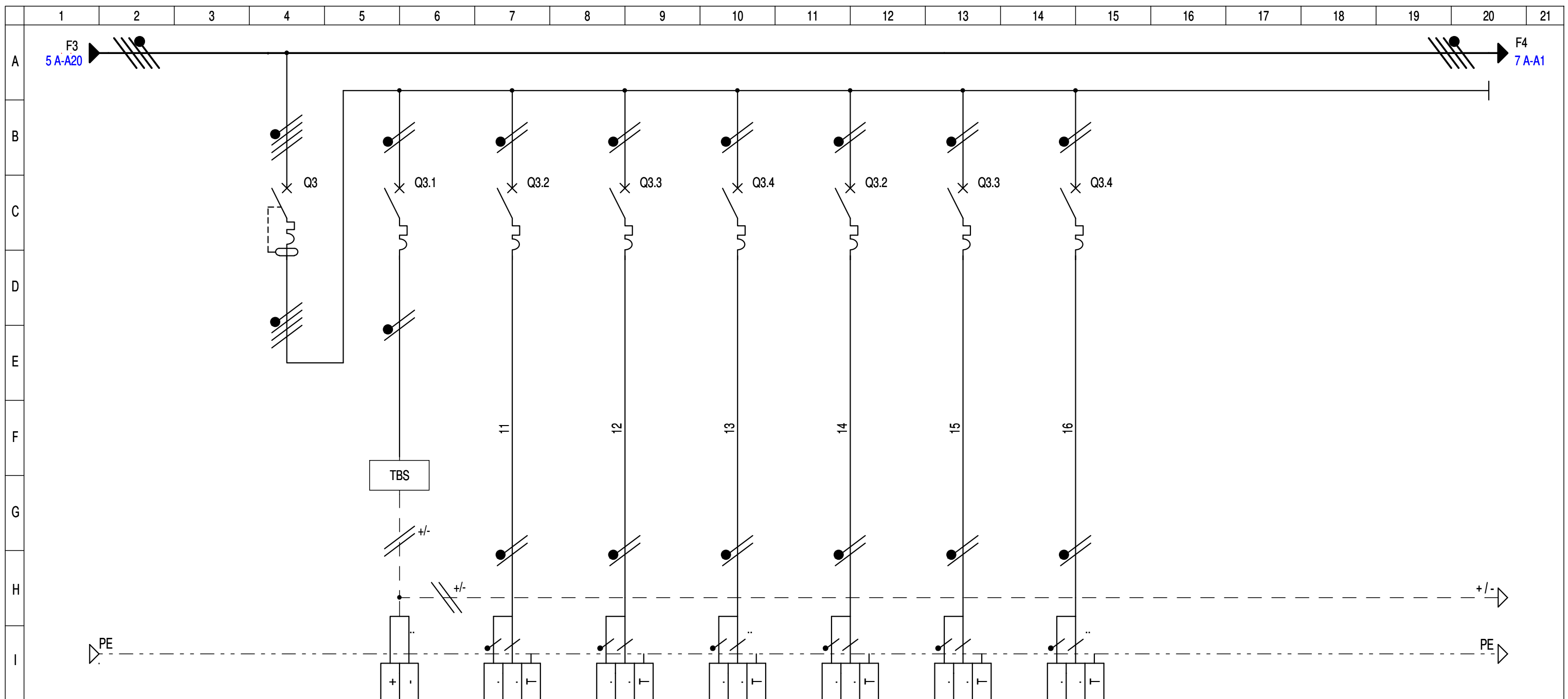

CIRCUIT	REPERE		TBS		ECL3.2		ECL3.3		ECL3.4		ECL3.5		ECL3.6		ECL3.7					
	DESIGNATION		GENERAL 1 ECLAIRAGE		TELECOMMANDE BAES		ECLAIRAGE 1		ECLAIRAGE 2		ECLAIRAGE 3		ECLAIRAGE 4		ECLAIRAGE 5		ECLAIRAGE 6			
CIRCUIT	Puissance	lb	-	-	-	-	-	-	-	-	-	-	-	-	-	-	-	-	-	-
	Répartition	Cos-Phi	-	-	-	-	-	-	-	-	-	-	-	-	-	-	-	-	-	-
	K Ut	DU Totale	-	-	-	-	-	-	-	-	-	-	-	-	-	-	-	-	-	-
PROTECTION	TYPE		iDT40N - C		iDT40T - C		iDT40T - C		iDT40T - C		iDT40T - C		iDT40T - C		iDT40T - C		iDT40T - C			
	CAL.(A)	DECLENCH.	20	3P+N	10	1P+N	10	1P+N	10	1P+N	10	1P+N	10	1P+N	10	1P+N	10	1P+N	-	-
	Ir.Th.(A)	Img (A)	20	200	10	100	10	100	10	100	10	100	10	100	10	100	10	100	-	-
	PROTECTION CI (mA)		30mA/AC		Prot.base		Prot.base		Prot.base		Prot.base		Prot.base		Prot.base		Prot.base			
LIAISON	NATURE																			
	LONGUEUR (m)	AME	-	-	-	-	-	-	-	-	-	-	-	-	-	-	-	-	-	-
	SECTION																			
	NEUTRE	SEPRE	-	-	-	-	-	-	-	-	-	-	-	-	-	-	-	-	-	-
	PE OU PEN	-	-	-	-	-	-	-	-	-	-	-	-	-	-	-	-	-	-	

DESSINE PAR: EVD  
DATE: 31/03/2023

AFFAIRE: SALLE DE SPORT



20B Rue Voltaire Pin  
27120 - AIGLEVILLE  
Tel : 06.10.62.05.24

DESIGNATION DU FOLIO:  
TABLEAU DIVISIONNAIRE SPORT  
CIRCUIT ECLAIRAGE 1

FOLIO:  
06/13 A

CE DOCUMENT EST NOTRE PROPRIETE, IL NE PEUT PAS ETRE UTILISE SANS NOTRE AUTORISATION

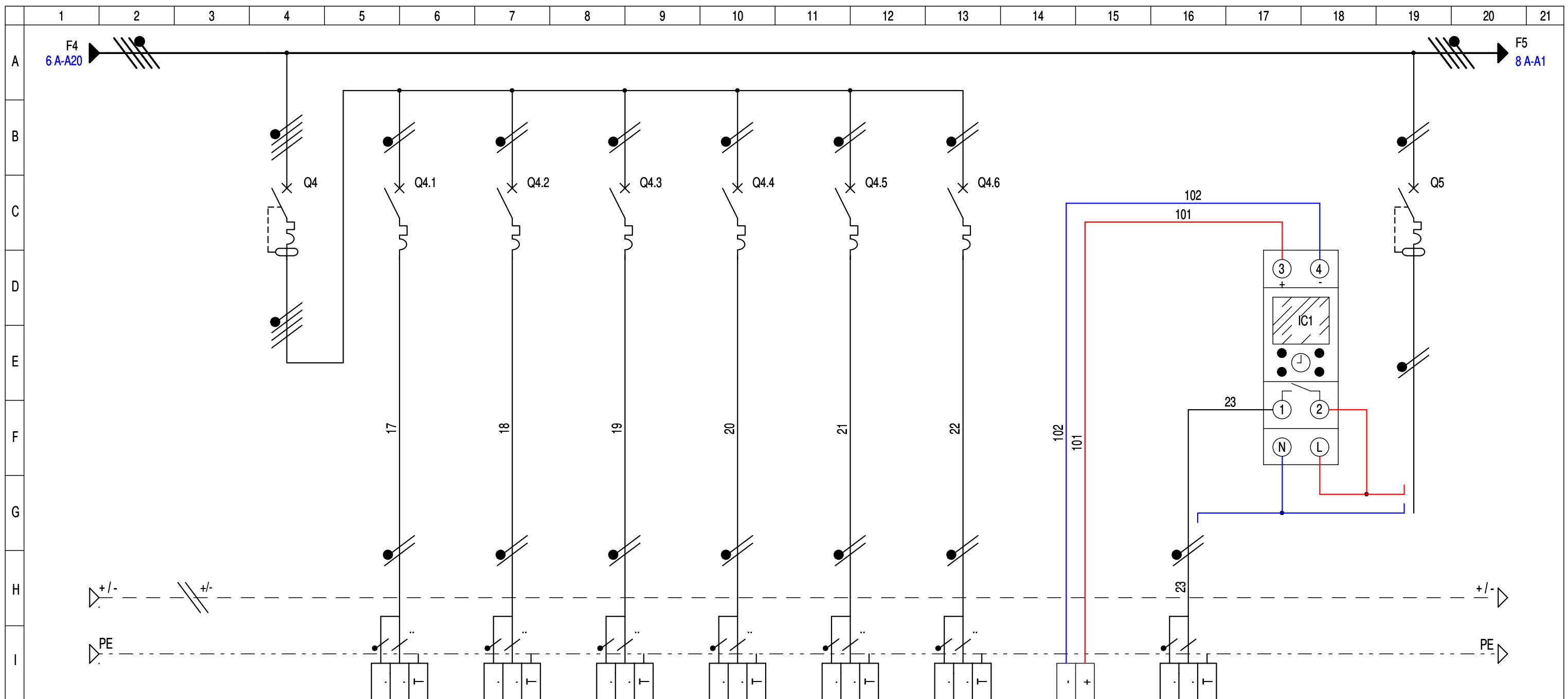

CIRCUIT	REPERE		ECL4.1		ECL4.2		ECL4.3		ECL4.4		ECL4.5		ECL4.6		CELLULE CREPUSCULAIRE		ECL5		INTER CREPUSCULAIRE THEBEN LUNA 108T		ECL5			
	DESIGNATION		GENERAL 2 ECLAIRAGE		ECLAIRAGE 7		ECLAIRAGE 8		ECLAIRAGE 9		ECLAIRAGE 10		ECLAIRAGE 11		ECLAIRAGE 12		ECLAIRAGE EXTERIEUR				ECLAIRAGE EXTERIEUR			
PROTECTION	Puissance	lb	-	-	-	-	-	-	-	-	-	-	-	-	-	-	-	-	-	-	-	-		
	Répartition	Cos-Phi	-	-	-	-	-	-	-	-	-	-	-	-	-	-	-	-	-	-	-	-		
	K Ut	DU Totale	-	-	-	-	-	-	-	-	-	-	-	-	-	-	-	-	-	-	-	-		
LIAISON	TYPE		iDT40N - C		iDT40T - C		iDT40T - C		iDT40T - C		iDT40T - C		iDT40T - C								iDT40T - C			
	CAL.(A)	DECLENCH.	20	3P+N	10	1P+N	10	1P+N	10	1P+N	10	1P+N	10	1P+N	10	1P+N	-	-	-	-	-	-	10	1P+N
	Ir.Th.(A)	Img (A)	20	200	10	100	10	100	10	100	10	100	10	100	10	100	-	-	-	-	-	-	10	100
	PROTECTION CI (mA)		30mA/AC		Prot.base		Prot.base		Prot.base		Prot.base		Prot.base										30mA/AC	
L	NATURE																							
	LONGUEUR (m)	AME	-	-	-	-	-	-	-	-	-	-	-	-	-	-	-	-	-	-	-	-	-	-
	SECTION																							
M	NEUTRE	SEPRE	-	-	-	-	-	-	-	-	-	-	-	-	-	-	-	-	-	-	-	-	-	-
	PE OU PEN		-	-	-	-	-	-	-	-	-	-	-	-	-	-	-	-	-	-	-	-	-	-

DESSINE PAR: EVD  
DATE: 31/03/2023

AFFAIRE: SALLE DE SPORT



20B Rue Voltaire Pin  
27120 - AIGLEVILLE  
Tel : 06.10.62.05.24

DESIGNATION DU FOLIO:  
TABLEAU DIVISIONNAIRE SPORT  
CIRCUIT ECLAIRAGE 2 + ECL.EXTERIEUR

FOLIO:  
07/13 A

CE DOCUMENT EST NOTRE PROPRIETE, IL NE PEUT PAS ETRE UTILISE SANS NOTRE AUTORISATION

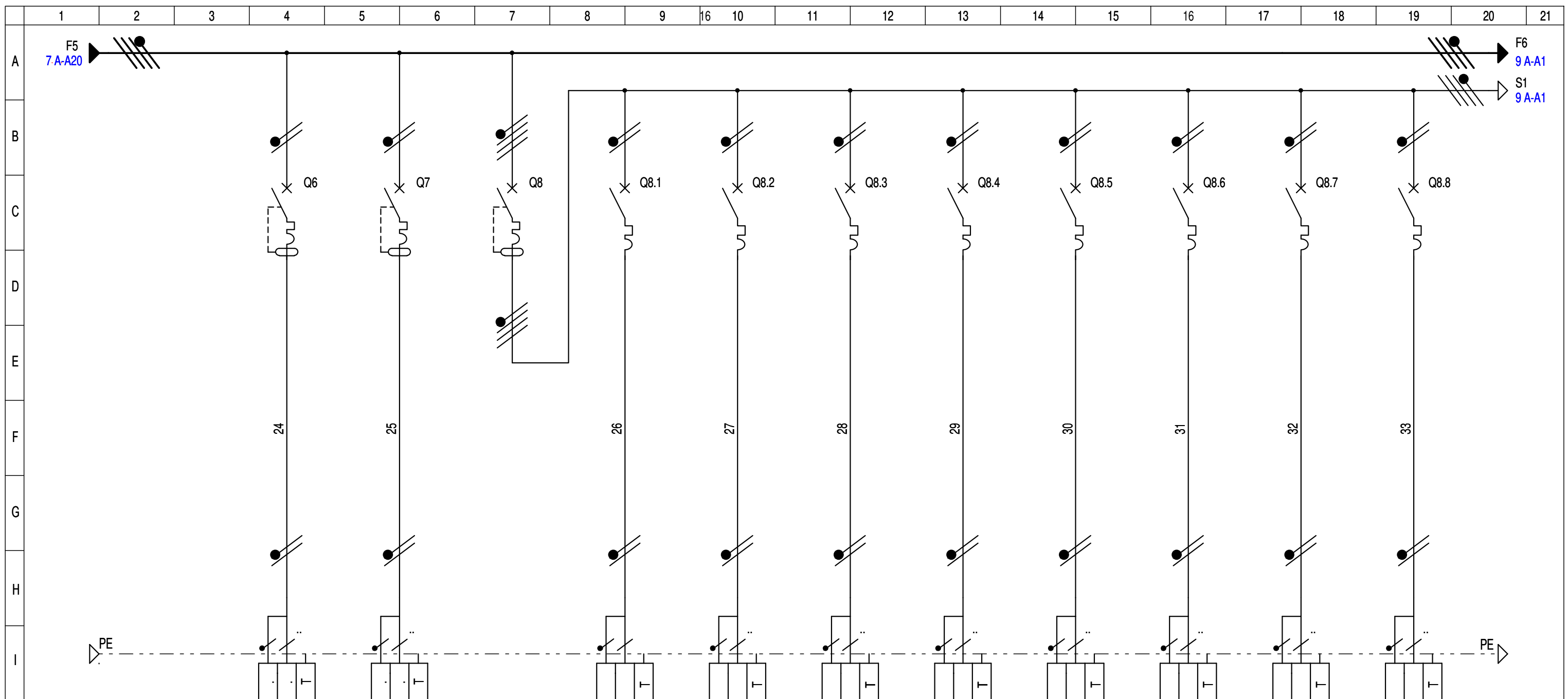

CIRCUIT	REPERE		PC6		FM7		GFC		CAS1		CAS2		CAS3		CAS4		CAS5		CAS6		CAS7		CAS8	
	DESIGNATION		BAIE INFORMATIQUE		VMC		GENERAL CASSETTE CLIM		CASSETTE 1		CASSETTE 2		CASSETTE 3		CASSETTE 4		CASSETTE 5		CASSETTE 6		CASSETTE 7		CASSETTE 8	
PROTECTION	Puissance	lb	-	-	-	-	-	-	-	-	-	-	-	-	-	-	-	-	-	-	-	-	-	-
	Répartition	Cos-Phi	-	-	-	-	-	-	-	-	-	-	-	-	-	-	-	-	-	-	-	-	-	-
	K Ut	DU Totale	-	-	-	-	-	-	-	-	-	-	-	-	-	-	-	-	-	-	-	-	-	-
LIAISON	TYPE		iDT40T - C		iDT40T - C		iDT40N - C		iDT40T - C		iDT40T - C		iDT40T - C		iDT40T - C		iDT40T - C		iDT40T - C		iDT40T - C		iDT40T - C	
	CAL.(A)	DECLENCH.	20	1P+N	16	1P+N	32	3P+N	10	1P+N	10	1P+N	10	1P+N	10	1P+N	10	1P+N	10	1P+N	10	1P+N	10	1P+N
	Ir.Th.(A)	lmg (A)	20	200	16	160	32	320	10	100	10	100	10	100	10	100	10	100	10	100	10	100	10	100
	PROTECTION CI (mA)		30mA/AC		30mA/AC		300mA/AC		Prot.base		Prot.base		Prot.base		Prot.base		Prot.base		Prot.base		Prot.base		Prot.base	
L	NATURE																							
	LONGUEUR (m)	AME																						
	SECTION																							
M	NEUTRE	SEPRE	-	-	-	-	-	-	-	-	-	-	-	-	-	-	-	-	-	-	-	-	-	-
	PE OU PEN		-	-	-	-	-	-	-	-	-	-	-	-	-	-	-	-	-	-	-	-	-	-

DESSINE PAR: EVD  
DATE: 31/03/2023

AFFAIRE: SALLE DE SPORT



20B Rue Voltaire Pin  
27120 - AIGLEVILLE  
Tel : 06.10.62.05.24

DESIGNATION DU FOLIO:  
TABLEAU DIVISIONNAIRE SPORT  
CIRCUIT DEPART DIRECT + FORCE CASSETTE

FOLIO:  
08/13 A



CE DOCUMENT EST NOTRE PROPRIETE, IL NE PEUT PAS ETRE UTILISE SANS NOTRE AUTORISATION

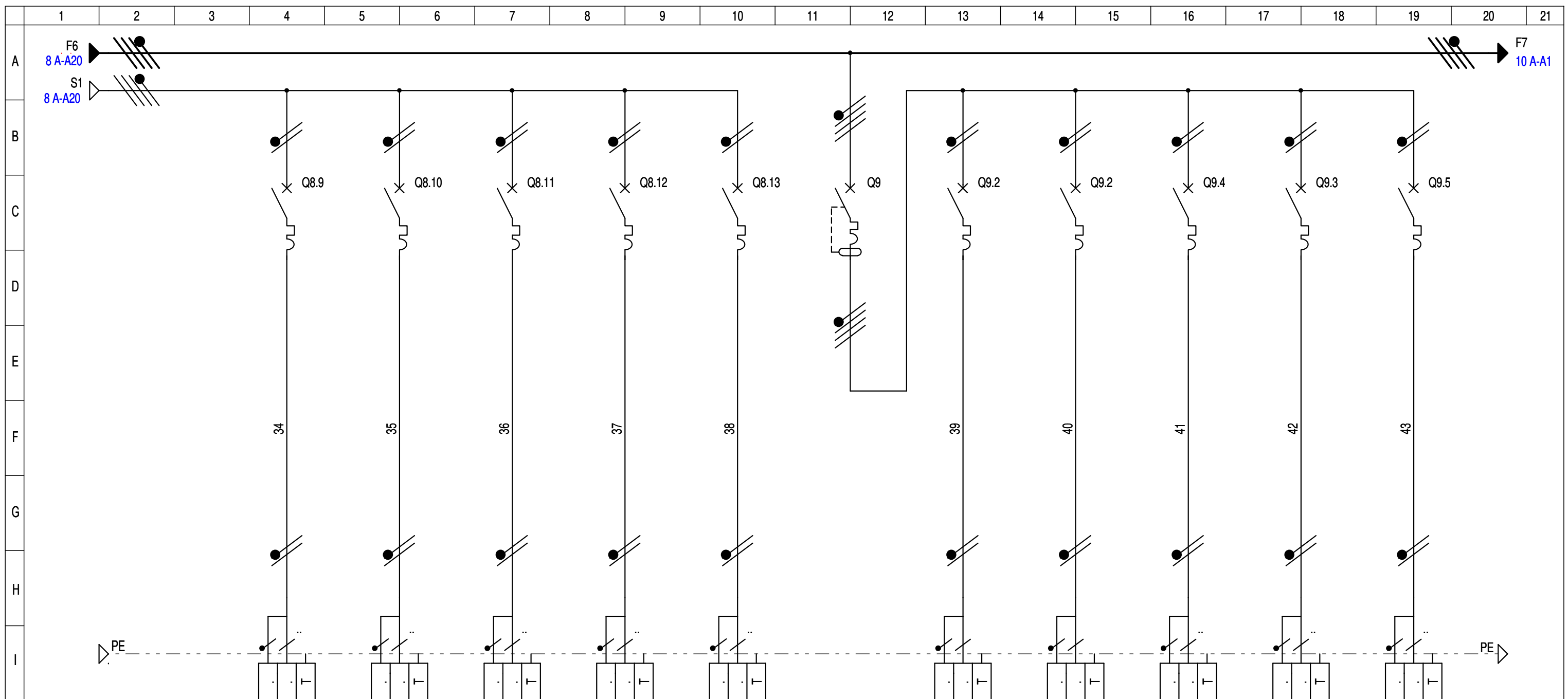

CIRCUIT	REPERE		CAS9		CAS10		CAS11		CAS12		CAS13		GFD		PC9.1		PC9.2		PC9.3		PC9.4		PC9.5	
	DESIGNATION		CASSETTE 9		CASSETTE 10		CASSETTE 11		CASSETTE 12		CASSETTE 13		GENERAL DIVERS		LAVE LINGE		SECHE LINGE		MACHINE A CAFE		MOULIN A CAFE		REFRIGERATEUR	
PROTECTION	Puissance	lb	-	-	-	-	-	-	-	-	-	-	-	-	-	-	-	-	-	-	-	-	-	-
	Répartition	Cos-Phi	-	-	-	-	-	-	-	-	-	-	-	-	-	-	-	-	-	-	-	-	-	-
	K Ut	DU Totale	-	-	-	-	-	-	-	-	-	-	-	-	-	-	-	-	-	-	-	-	-	-
LIAISON	TYPE		iDT40T - C		iDT40T - C		iDT40T - C		iDT40T - C		iDT40T - C		iDT40N - C		iDT40T - C		iDT40T - C		iDT40T - C		iDT40T - C		iDT40T - C	
	CAL.(A)	DECLENCH.	10	1P+N	10	1P+N	10	1P+N	10	1P+N	10	1P+N	32	3P+N	20	1P+N	20	1P+N	16	1P+N	16	1P+N	16	1P+N
	Ir.Th.(A)	Img (A)	10	100	10	100	10	100	10	100	10	100	32	320	20	200	20	200	16	160	16	160	16	160
	PROTECTION CI (mA)		Prot.base		Prot.base		Prot.base		Prot.base		Prot.base		30mA/AC		Prot.base		Prot.base		Prot.base		Prot.base		Prot.base	
L	NATURE																							
	LONGUEUR (m)	AME	.	.	.	.	.	.	.	.	.	.	.	.	.	.	.	.	.	.	.	.	.	.
	SECTION																							
	NEUTRE	SEPRE	-	-	-	-	-	-	-	-	-	-	-	-	-	-	-	-	-	-	-	-	-	-
M	PE OU PEN																							

DESSINE PAR: EVD  
DATE: 31/03/2023

AFFAIRE: SALLE DE SPORT



20B Rue Voltaire Pin  
27120 - AIGLEVILLE  
Tel : 06.10.62.05.24

DESIGNATION DU FOLIO:  
TABLEAU DIVISIONNAIRE SPORT  
CIRCUIT FORCE CLIM (Suite) ET DIVERS

FOLIO:  
09/13 A

CE DOCUMENT EST NOTRE PROPRIETE, IL NE PEUT PAS ETRE UTILISE SANS NOTRE AUTORISATION

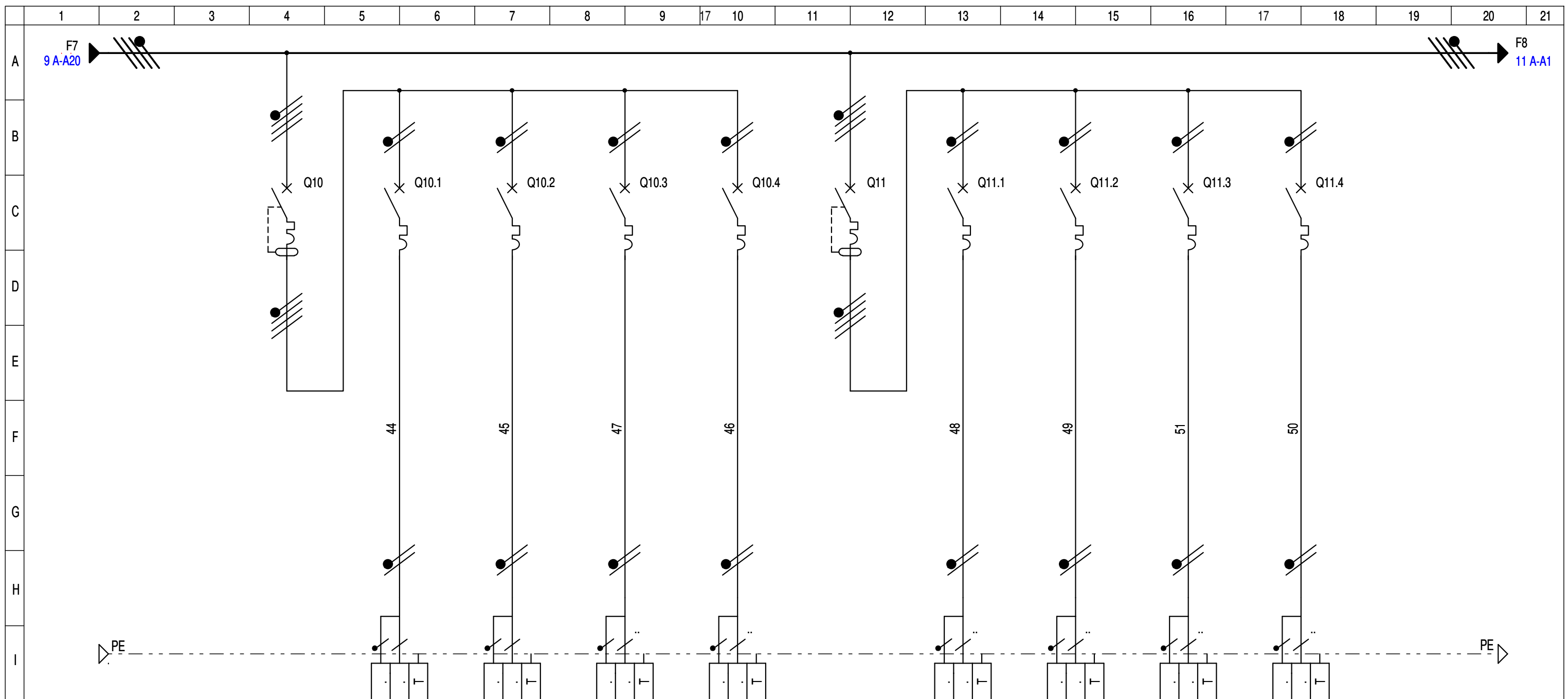

CIRCUIT	REPERE		GFCAR1		PC10.1		PC10.2		PC10.3		PC10.4		GFCAR2		PC11.1		PC11.2		PC11.3		PC11.4			
	DESIGNATION		GENERAL 1 CARDIO TAPIS-PRESSE		CARDIO 1		CARDIO 2		TAPIS DE COURSE 1		PRESSE CUISSE 1		GENERAL 2 CARDIO TAPIS-PRESSE		CARDIO 3		CARDIO 4		TAPIS DE COURSE 2		PRESSE CUISSE 2			
	Puissance	lb	-	-	0.75kW	4.1	0.75kW	4.1	3.5kW	18	1.5kW	8.1	-	-	0.75kW	4.1	0.75kW	4.1	3.5kW	18	1.5kW	8.1	-	-
	Répartition	Cos-Phi	-	-	-	-	-	-	-	-	-	-	-	-	-	-	-	-	-	-	-	-	-	-
	K Ut	DU Totale	-	-	-	-	-	-	-	-	-	-	-	-	-	-	-	-	-	-	-	-	-	-
PROTECTION	TYPE		iDT40N - C		iDT40T - C		iDT40T - C		iDT40T - C		iDT40T - C		iDT40N - C		iDT40T - C		iDT40T - C		iDT40T - C		iDT40T - C		-	
	CAL.(A)	DECLENCH.	32	3P+N	16	1P+N	16	1P+N	20	1P+N	16	1P+N	32	3P+N	16	1P+N	16	1P+N	20	1P+N	16	1P+N	-	-
	Ir.Th.(A)	Img (A)	32	320	16	160	16	160	20	200	16	160	32	320	16	160	16	160	20	200	16	160	-	-
	PROTECTION CI (mA)		30mA/Asi		Prot.base		Prot.base		Prot.base		Prot.base		30mA/Asi		Prot.base		Prot.base		Prot.base		Prot.base		-	
LIAISON	NATURE																							
	LONGUEUR (m)	AME																						
	SECTION																							
	NEUTRE	SEPRE	-	-	-	-	-	-	-	-	-	-	-	-	-	-	-	-	-	-	-	-	-	-
	PE OU PEN	-	-	-	-	-	-	-	-	-	-	-	-	-	-	-	-	-	-	-	-	-	-	-

DESSINE PAR: EVD  
DATE: 31/03/2023

AFFAIRE: SALLE DE SPORT



20B Rue Voltaire Pin  
27120 - AIGLEVILLE  
Tel : 06.10.62.05.24

DESIGNATION DU FOLIO:  
TABLEAU DIVISIONNAIRE SPORT  
CIRCUIT FORCE CARDIO 1/2 ET 3/4

FOLIO:  
10/13 A

CE DOCUMENT EST NOTRE PROPRIETE, IL NE PEUT PAS ETRE UTILISE SANS NOTRE AUTORISATION

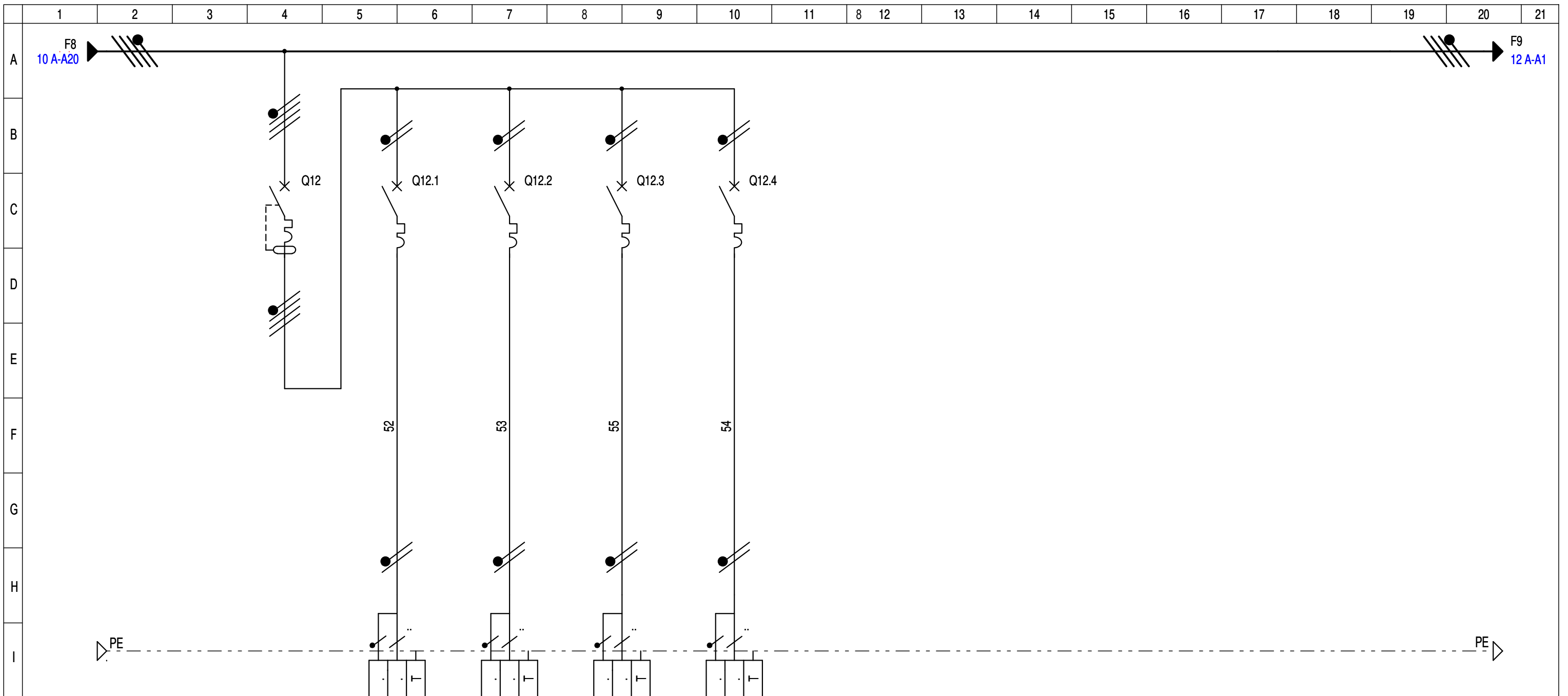

CIRCUIT	REPERE		GFCAR3		PC12.1		PC12.2		PC12.3		PC12.4									
	DESIGNATION		GENERAL 3 CARDIO 5/6 - HUB TAPIS COURSE 3		CARDIO 5		CARDIO 6		TAPIS DE COURSE 3		HUB									
PROTECTION	Puissance	lb	-	-	0.75kW	4.1	0.75kW	4.1	3.5kW	18	1.5kW	8.1	-	-	-	-	-	-	-	-
	Répartition	Cos-Phi	-	-	-	-	-	-	-	-	-	-	-	-	-	-	-	-	-	-
	K Ut	DU Totale	-	-	-	-	-	-	-	-	-	-	-	-	-	-	-	-	-	-
LIAISON	TYPE		iDT40N - C		iDT40T - C		iDT40T - C		iDT40T - C		iDT40T - C									
	CAL.(A)	DECLENCH.	32	3P+N	16	1P+N	16	1P+N	20	1P+N	16	1P+N	-	-	-	-	-	-	-	-
	Ir.Th.(A)	Img (A)	32	320	16	160	16	160	20	200	16	160	-	-	-	-	-	-	-	-
PROTECTION CI (mA)			30mA/Asi		Prot.base		Prot.base		Prot.base		Prot.base									
NATURE																				
LONGUEUR (m)		AME																		
SECTION																				
NEUTRE		SEPRE																		
PE OU PEN																				

DESSINE PAR: EVD  
DATE: 31/03/2023

AFFAIRE: SALLE DE SPORT



20B Rue Voltaire Pin  
27120 - AIGLEVILLE  
Tel : 06.10.62.05.24

DESIGNATION DU FOLIO:  
TABLEAU DIVISIONNAIRE SPORT  
CIRCUIT FORCE CARDIO 5/6

FOLIO:  
11/13 A

CE DOCUMENT EST NOTRE PROPRIETE, IL NE PEUT PAS ETRE UTILISE SANS NOTRE AUTORISATION

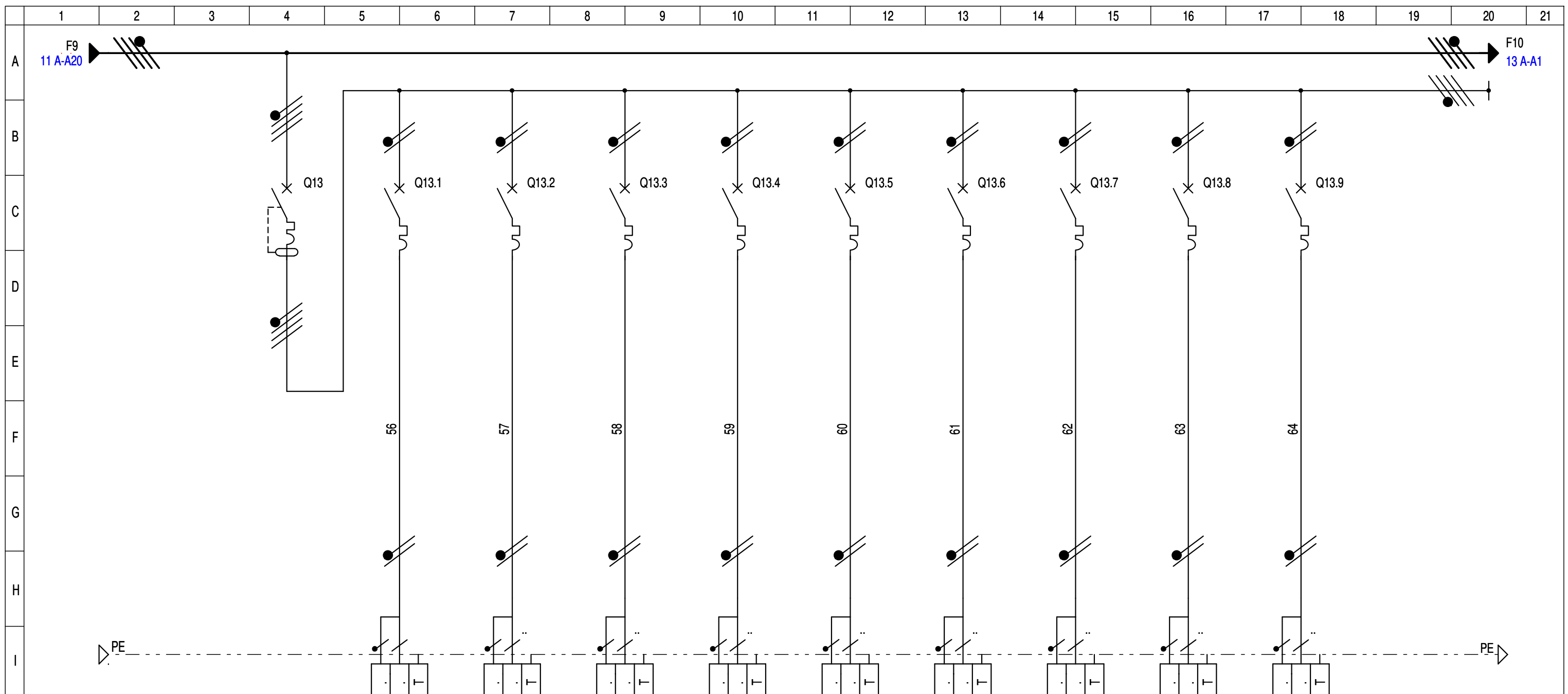

CIRCUIT	REPERE		PC12.5		RES13.1		RES13.2		RES13.3		RES13.4		RES13.5		RES13.6		RES13.7		RES13.8		RES13.9			
	DESIGNATION		GENERAL SECHE SERVIETTE SECHE MAINS		SECHE MAINS 1		SECHE MAINS 2		SECHE SERVIETTE 1		SECHE SERVIETTE 2		SECHE SERVIETTE 3		SECHE SERVIETTE 4		SECHE SERVIETTE 5		SECHE SERVIETTE 6		SECHE SERVIETTE 7			
K	Puissance	lb	-	-	2kW	8.7	2kW	8.7	2kW	8.7	2kW	8.7	2kW	8.7	2kW	8.7	2kW	8.7	2kW	8.7	2kW	8.7		
	Répartition	Cos-Phi	-	-	-	-	-	-	-	-	-	-	-	-	-	-	-	-	-	-	-	-		
	K Ut	DU Totale	-	-	-	-	-	-	-	-	-	-	-	-	-	-	-	-	-	-	-	-		
L	TYPE		iDT40N - C		iDT40T - C		iDT40T - C		iDT40T - C		iDT40T - C		iDT40T - C		iDT40T - C		iDT40T - C		iDT40T - C		iDT40T - C			
	CAL.(A)	DECLENCH.	32	3P+N	16	1P+N	16	1P+N	16	1P+N	16	1P+N	16	1P+N	16	1P+N	16	1P+N	16	1P+N	16	1P+N		
	Ir.Th.(A)	lmg (A)	32	320	16	160	16	160	16	160	16	160	16	160	16	160	16	160	16	160	16	160		
	PROTECTION CI (mA)		30mA/AC		Prot.base		Prot.base		Prot.base		Prot.base		Prot.base		Prot.base		Prot.base		Prot.base		Prot.base		Prot.base	
M	NATURE																							
	LONGUEUR (m)	AME																						
	SECTION																							
LIAISON	NEUTRE	SEPRE	-	-	-	-	-	-	-	-	-	-	-	-	-	-	-	-	-	-	-	-		
	PE OU PEN		-	-	-	-	-	-	-	-	-	-	-	-	-	-	-	-	-	-	-	-		

DESSINE PAR: EVD  
DATE: 31/03/2023

AFFAIRE: SALLE DE SPORT



20B Rue Voltaire Pin  
27120 - AIGLEVILLE  
Tel : 06.10.62.05.24

DESIGNATION DU FOLIO:  
TABLEAU DIVISIONNAIRE SPORT  
CIRCUIT FORCE SECHE MAINS - SECHE SERVIETTE

FOLIO:  
12/13 A

CE DOCUMENT EST NOTRE PROPRIETE, IL NE PEUT PAS ETRE UTILISE SANS NOTRE AUTORISATION

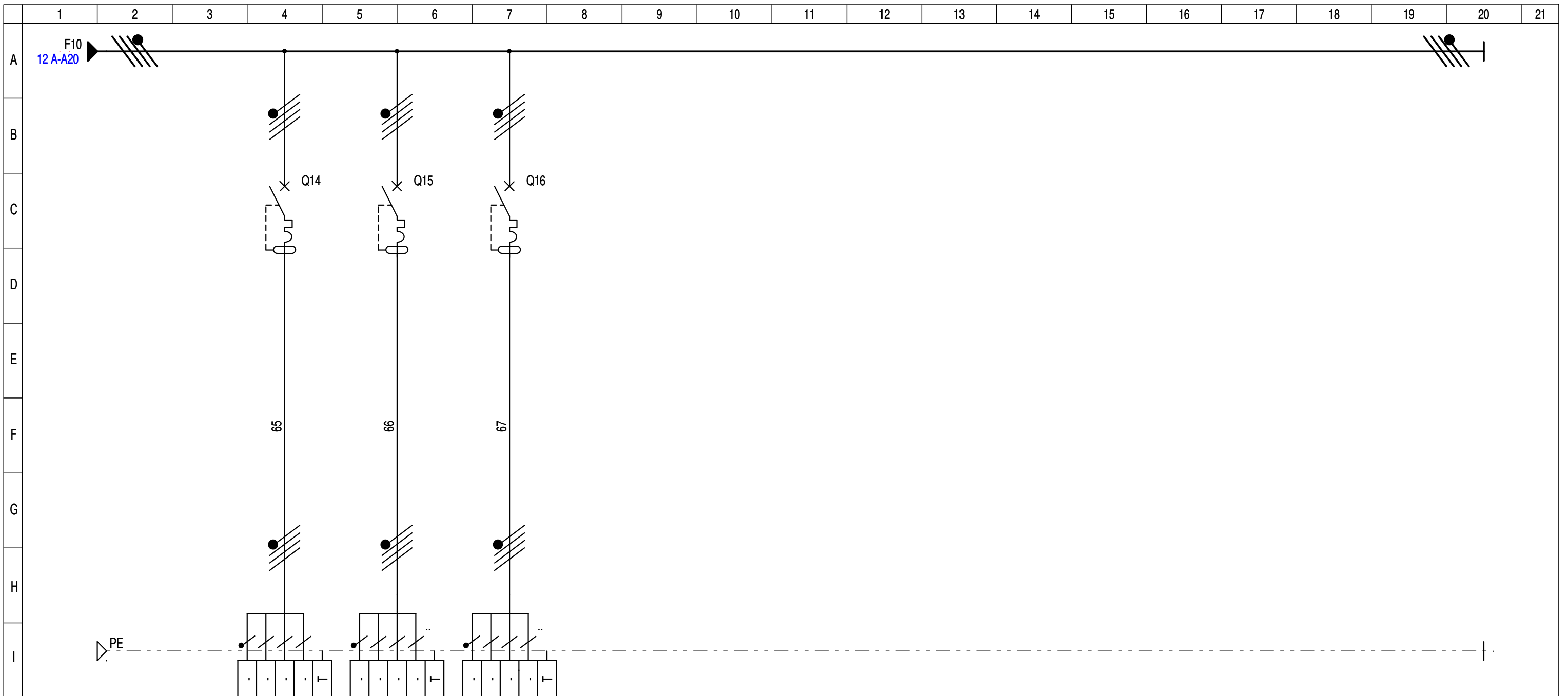

CIRCUIT	REPERE		CTA1		CTA2		ASC1													
	DESIGNATION		ALIMENTATION CTA25		ALIMENTATION CTA SALLE DE SPORT		ALIMENTATION ASCENSEUR													
CIRCUIT	Puissance	lb	14kW	25.3	7.5kW	13.5	7.5kW	13.5	-	-	-	-	-	-	-	-	-	-	-	-
	Répartition	Cos-Phi	-	-	-	-	-	-	-	-	-	-	-	-	-	-	-	-	-	-
	K Ut	DU Totale	-	-	-	-	-	-	-	-	-	-	-	-	-	-	-	-	-	-
PROTECTION	TYPE		iDT40N - C		iDT40N - C		iDT40N - D													
	CAL.(A)	DECLENCH.	32	3P+N	16	3P+N	20	3P+N	-	-	-	-	-	-	-	-	-	-	-	-
	Ir.Th.(A)	Img (A)	32	448	16	224	20	280	-	-	-	-	-	-	-	-	-	-	-	-
	PROTECTION CI (mA)		300mA/AC		300mA/AC		300mA/AC													
LIAISON	NATURE																			
	LONGUEUR (m)	AME	-	-	-	-	-	-	-	-	-	-	-	-	-	-	-	-	-	-
	SECTION																			
	NEUTRE	SEPRE	-	-	-	-	-	-	-	-	-	-	-	-	-	-	-	-	-	-
	PE OU PEN		-	-	-	-	-	-	-	-	-	-	-	-	-	-	-	-	-	-

DESSINE PAR: EVD  
DATE: 31/03/2023

AFFAIRE: SALLE DE SPORT



20B Rue Voltaire Pin  
27120 - AIGLEVILLE  
Tel : 06.10.62.05.24

DESIGNATION DU FOLIO:  
TABLEAU DIVISIONNAIRE SPORT  
CIRCUIT FORCE CTA - ASCENSEUR

FOLIO:  
13/13 A